



# SPECTRUM

SYSTEMENTWICKLUNG MICROELECTRONIC GMBH

## MI.31xx - 8 channel 12 bit A/D up to 25 MS/s

- Standard PCI format
- 12 bit A/D converter board
- 1 MS/s, 10 Ms/s or 25 MS/s
- 2, 4 or 8 channels per board
- Simultaneously sampling on all channels
- 8 input ranges:  $\pm 50$  mV up to  $\pm 10$  V
- Up to 256 MSample memory
- FIFO mode to RAM or hard disk
- Window and Pulsewidth trigger
- Input offset up to  $\pm 100\%$
- Synchronization possible
- Windows program SBench 5.x included

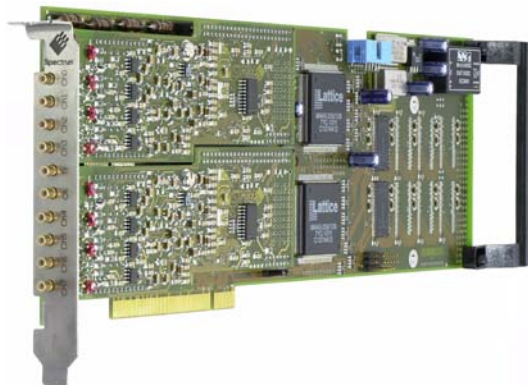

### Product range overview

Model	1 channel	2 channels	4 channels	8 channels
MI.3110	1 MS/s	1 MS/s		
MI.3111	1 MS/s	1 MS/s	1 MS/s	
MI.3112	1 MS/s	1 MS/s	1 MS/s	1 MS/s
MI.3120	10 MS/s	10 MS/s		
MI.3121	10 MS/s	10 MS/s	10 MS/s	
MI.3122	10 MS/s	10 MS/s	10 MS/s	10 MS/s
MI.3130	25 MS/s	25 MS/s		
MI.3131	25 MS/s	25 MS/s	25 MS/s	
MI.3132	25 MS/s	25 MS/s	25 MS/s	25 MS/s

### Software/Drivers

A large number of drivers and examples are delivered with the board or are available as an option:

- Windows 98/ME/NT/2000/XP - drivers
- Linux - drivers
- SBench 5.2
- Streaming Software SPviewIT 6.1 (as option)
- Microsoft Visual C++ examples
- Borland Delphi examples
- Microsoft Visual Basic examples
- Microsoft Excel examples
- LabWindows/CVI examples
- FlexPro support with SBench
- LabVIEW - drivers (as option)
- DASYLab - drivers (as option)
- MATLAB - drivers (as option)
- Agilent VEE - drivers (as option)

### General Information

The MI.31xx series allows recording of two, four or eight channels with samplersates of 1 MS/s, 10 MS/s or 25 MS/s. Due to the proven design a wide variety of 12 bit A/D converter boards for PCI bus could be offered. These boards are available in several versions and different speed grades making it possible for the user to find an individual solution.

As an option 4 digital inputs per channel could be recorded synchronously. The installed memory of up to 256 MSample will be used for fast data recording. It can completely be used by the currently active channels. If using slower samplersates the memory is switched to a FIFO buffer and data will be transferred on-line to the PC memory or to hard disk.

### Hardware block diagram

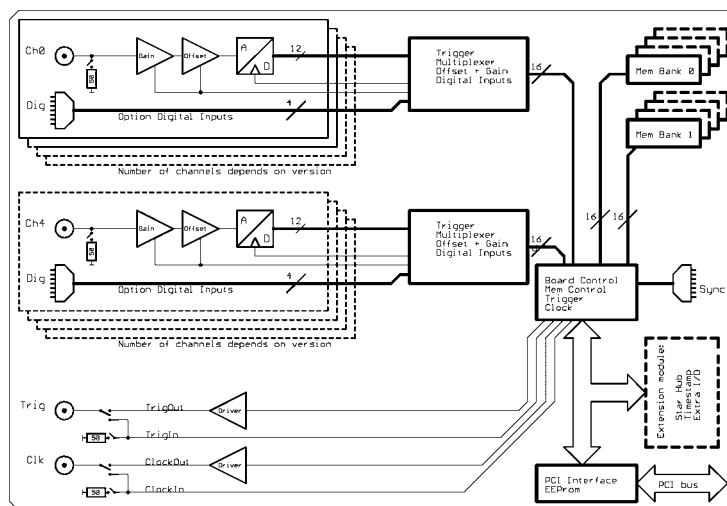

### Software programmable parameters

Samplerate	1 kS/s to max samplerate, external clock, ref clock
Input Range	$\pm 50$ mV, $\pm 100$ mV, $\pm 200$ mV, $\pm 500$ mV, $\pm 1$ V, $\pm 2$ V, $\pm 5$ V, $\pm 10$ V
Input impedance	50 Ohm / 1 MOhm
Input Offset	$\pm 100\%$ in steps of 1%
Clock impedance	50 Ohm / 1 MOhm
Trigger impedance	50 Ohm / 1 MOhm
Trigger mode	Channel, External, Software, Auto, Windows, Pulse
Trigger level	1/256 to 255/256 of input range
Trigger edge	rising edge, falling edge or both edges
Trigger pulsewidth	1 to 255 samples in steps of 1 sample
Memory depth	32 up to installed memory in steps of 32
Posttrigger	32 up to 128 M in steps of 32
Multiple Recording segmentsize	32 up to installed memory / 2 in steps of 32

## Possibilities and options

### Input impedance

All inputs could individually be switched by software between 50 Ohm and 1 MOhm input impedance. If using fast signals and high sampling rates or have 50 Ohm cable impedance the use of the 50 Ohm termination is recommended to minimise noise and signal reflections. If using weak signal sources or standard probes the use of the 1 MOhm termination is helpful.

### Ring buffer mode

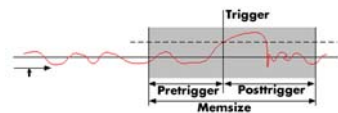

The ring buffer mode is the standard mode of all oscilloscope boards. Data is written in a ring memory of the board until a trigger event is detected.

After the event the posttrigger values are recorded. Because of this continuously recording in a ring buffer there are also samples prior to the trigger event visible: Pretrigger = Memsize - Posttrigger.

### FIFO mode

The FIFO mode is designed for continuous data transfer between measurement board and PC memory (up to 100 MB /s) or hard disk (up to 50 MB/s). The control of the data stream is done automatically by the driver on interrupt request.

### Channel trigger

The data acquisition boards offer a wide variety of trigger modes. Besides the standard signal checking for level and edge as known from oscilloscopes it's also possible to define a window trigger. All trigger modes could be combined with the pulsewidth trigger. This makes it possible to trigger on signal errors like too long or too short pulses.

### External trigger I/O

All boards could be triggered using an external TTL signal. It's possible to use positive or negative edge also in combination with a programmable pulsewidth. An internally recognised trigger event could - activated by software - routed to the output connector to start external instruments.

### Pulse width

Defines the minimum or maximum width that a trigger pulse could have to generate a trigger event. Could be combined with channel trigger, pattern trigger and external trigger.

### Multiple Recording

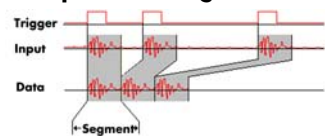

The Multiple Recording option allows the recording of several trigger events without restarting the hardware. With this option very fast repetition rates could be achieved. The

on-board memory is divided in several segments of same size. Each of them is filled with data if a trigger event occurs.

### Gated Sampling

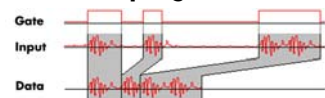

The Gated Sampling option allows data recording controlled by an external gate signal. Data is only recorded if the gate signal has a pro-

grammed level.

### External clock I/O

Using an external connector a sampling clock could be fed in from an external system. It's also possible to put out the internally used sampling clock to synchronise external equipment to this clock.

### Reference clock

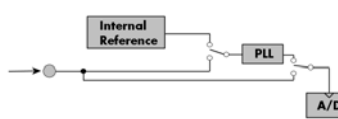

The option to use a precise external reference clock (normally 10 MHz) is necessary to synchronise the board for high-quality mea-

surements with external equipment (like a signal source). It's also possible to enhance the quality of the sampling clock this way. The driver automatically generates the requested sampling clock from the fed in reference clock.

### Digital inputs

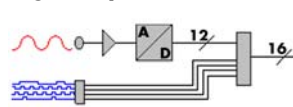

This option acquires additional synchronous digital channels phase-stable with the analog data. When the option is installed there are 4 additional digital inputs for every analog A/D channel.

### Cascading

The cascading option synchronises up to 4 Spectrum boards internally. It's the simplest way to build up a multi channel system. There is a phase delay between two boards of about 500 pico seconds when this synchronisation option is used.

### Star hub

The star hub is an additional module allowing the phase stable synchronisation of up to 16 boards. Independent of the number of boards there is no phase delay between all channels. The star hub distributes trigger and clock information between all boards. As a result all connected boards are running with the same clock and the same trigger.

### Extra I/O

The Extra I/O module adds 24 additional digital I/O lines and 4 analog outputs on an extra connector. These additional lines are independent from the standard function and could be controlled asynchronously. There is also an internal version available with 16 digital I/Os and 4 analog outputs that could be used directly at the rear board connector.

### Timestamp

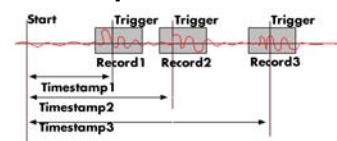

The timestamp option writes the time positions of the trigger events in an extra memory. The timestamps are relatively to the start of recording, to a defined zero time or externally synchronised to a radio clock or a GPS receiver. With this option acquisitions of systems on different locations could be set in a precise time relation.

## Technical Data

Resolution	12 bit	Dimension	312 mm x 107 mm
Differential linearity error	≤ 1 LSB (ADC)	Width (Standard)	1 full size slot
Integral linearity error	≤ 2.5 LSB (ADC)	Width (with digital inputs)	1 full size slot and 1 half size slot
Multi: Trigger to 1st sample delay	fix	Connector	3 mm SMB male
Multi: Recovery time	< 20 samples	Input impedance	50 Ohm / 1 MOhm    25 pF
ext. Trigger accuracy	1 Samples	Overvoltage protection	±20 V
int. Trigger accuracy	1 Sample	Warm up time	10 minutes
Ext. clock: delay to internal clock	42 ns ±2 ns	Operating temperature	0°C - 50°C
input signal with 50 ohm termination	max 5 V rms	Storage temperature	-10°C - 70°C
Digital Inputs input impedance	110 Ohm @ 2.5 V	Humidity	10% to 90%
Min internal clock	1 kS/s	Power consumption 5 V @ full speed	max 3.3 A (16.5 Watt)
Min external clock	1 kS/s	Power consumption 5 V @ power down	max 2.5 A (12.5 Watt)

Input range	±50 mV	±100 mV	±200 mV	±500 mV	±1 V	±2 V	±5 V	±10 V
Software programmable offset	±50 mV	±100 mV	±200 mV	±500 mV	±1 V	±2 V	±5 V	±10 V
Offset error	< 1 LSB, adjustable by user							
Gain error	< 1 %	< 1 %	< 1 %	< 1 %	< 1 %	< 1 %	< 1 %	< 1 %
Noise (rms): 50 Ohm, 25 MS/s	< 1.5 LSB	< 1.2 LSB	< 1.0 LSB	< 1.0 LSB	< 1.0 LSB	< 1.0 LSB	< 1.0 LSB	< 1.0 LSB
Crosstalk 500 kHz signal, ±50 mV input, 50 Ohm	< -70 dB							

## Dynamic Parameters

	MI.3110 MI.3111	MI.3112	MI.3120 MI.3121	MI.3122	MI.3130 MI.3131	MI.3132
max internal clock	1 MS/s	1 MS/s	10 MS/s	10 MS/s	25 MS/s	25 MS/s
max external clock	1 MS/s	1 MS/s	10 MS/s	10 MS/s	25 MS/s	25 MS/s
-3 dB bandwidth	> 500 kHz	> 500 kHz	> 5 MHz	> 5 MHz	> 12.5 MHz	> 12.5 MHz
Test - Samplerate	1 MS/s	1 MS/s	10 MS/s	10 MS/s	25 MS/s	25 MS/s
Testsignal frequency	90 kHz	90 kHz	1 MHz	1 MHz	1 MHz	1 MHz
SNR (typ)	> 68.2 dB	> 67.5 dB	> 65.5 dB	> 65.4 dB	> 63.5 dB	> 62.8 dB
THD (typ)	< -62.8 dB	< -62.8 dB	< -62.5 dB	< -62.5 dB	< -62.5 dB	< -62.5 dB
SFDR (typ), excl harm.	> 80.8 dB	> 80.5 dB	> 80.5 dB	> 78.5 dB	> 79.5 dB	> 79.3 dB
SINAD (typ)	> 61.7 dB	> 61.5 dB	> 60.7 dB	> 60.7 dB	> 60.0 dB	> 59.6 dB
ENOB (based on SINAD)	10.0	9.9	9.8	9.8	9.7	9.6

Dynamic parameters are measured at ± 1 V input range and 50 Ohm termination with the samplerate specified in the table. Measured parameters are averaged 20 times to get typical values. Test signal is a pure sine wave of the specified frequency with > 99% amplitude. SNR and RMS noise parameters may differ depending on the quality of the used PC. SNR = Signal to Noise Ratio, THD = Total Harmonic Distortion, SFDR = Spurious Free Dynamic Range, SINAD = Signal Noise and Distortion, ENOB = Effective Number of Bits. For a detailed description please see application note 002.

## Order information

Order No	Description	Order No	Description
MI3110	MI.3110 with 8 MSample memory and drivers/SBench 5.x	MI3xxx-16M	Option: 16 MSample memory instead of 8 MSample standard mem
MI3111	MI.3111 with 8 MSample memory and drivers/SBench 5.x	MI3xxx-32M	Option: 32 MSample memory instead of 8 MSample standard mem
MI3112	MI.3112 with 8 MSample memory and drivers/SBench 5.x	MI3xxx-64M	Option: 64 MSample memory instead of 8 MSample standard mem
MI3120	MI.3120 with 8 MSample memory and drivers/SBench 5.x	MI3xxx-128M	Option: 128 MSample memory instead of 8 MSample standard mem
MI3121	MI.3121 with 8 MSample memory and drivers/SBench 5.x	MI3xxx-256M	Option: 256 MSample memory instead of 8 MSample standard mem
MI3122	MI.3122 with 8 MSample memory and drivers/SBench 5.x	MI3xxx-up	Additional handling costs for later memory upgrade
MI3130	MI.3130 with 8 MSample memory and drivers/SBench 5.x		
MI3131	MI.3131 with 8 MSample memory and drivers/SBench 5.x	MI3xxx-mr	Option Multiple Recording: Memory segmentation
MI3132	MI.3132 with 8 MSample memory and drivers/SBench 5.x	MI3xxx-gs	Option Gated Sampling: Gate signal controls acquisition
		MI3xxx-dig	Additional 4 synchronous digital inputs per channel, incl. cable
MI3xxx-smod	Star Hub: Synchronisation of 2 - 16 boards, one option per system		
MIxxxx-xio	Extra I/O, internal connector: 16 DI/O, 4 Analog out	MI31xx-dl	DASYLab driver for MI.31xx series
MI3xxx-time	Timestamp option: Extra memory for trigger time	MI31xx-hp	VEE driver for MI.31xx series
MIxxxx-xmf	Extra I/O, external connector: 24 DI/O, 4 Analog out, incl. cable	MI31xx-lv	LabVIEW driver for MI.31xx series
MI3xxx-cs	Synchronisation of 2 - 4 boards, one option per system	MATLAB	MATLAB driver for all MI.xxxx, MC.xxxx and MX.xxxx series.
Cab-3f-9m-80	Adapter cable: SMB female to BNC male 80 cm	Cab-3f-9f-80	Adapter cable: SMB female to BNC female 80 cm
Cab-3f-9m-200	Adapter cable: SMB female to BNC male 200 cm	Cab-3f-9f-200	Adapter cable: SMB female to BNC female 200 cm

technical Changes and printing errors possible