



SPECTRUM

SYSTEMENTWICKLUNG MICROELECTRONIC GMBH

M2i.30xx - 12 bit transient recorder up to 200 MS/s

- Up to 200 MS/s on one channel, 100 MS/s on two channels or 60 MS/s on four channels
- Simultaneously sampling on all channels
- Separate ADC and amplifier per channel
- 6 input ranges: ± 200 mV up to ± 10 V
- Up to 2 GSample (4 GByte) on-board memory
- 128 MSample standard memory installed
- Window, pulse width, re-arm, OR/AND trigger
- Programmable input offset of $\pm 100\%$
- Synchronization of up to 16 cards per system
- Systems with up to 271 synchronous cards with system-synchronisation
- Options: synchronous digital channels, Gated Sampling, Timestamps, ABA mode.

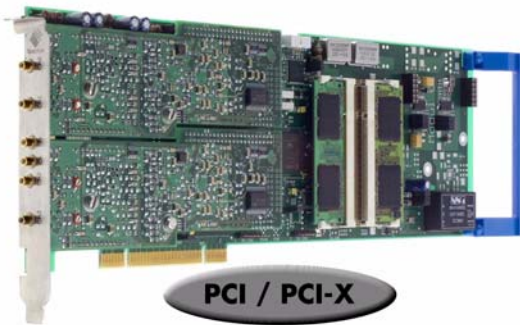

PCI / PCI-X

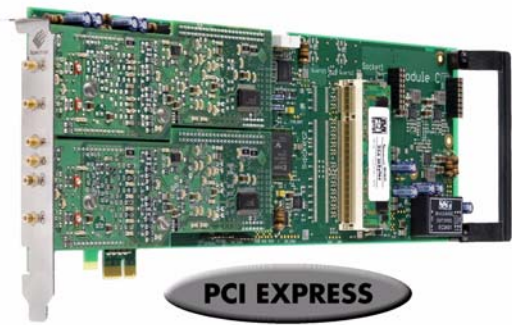

PCI EXPRESS

- 66 MHz 32 bit PCI-X interface
- 5V / 3.3V PCI compatible
- 100% compatible to conventional PCI > V2.1
- Sustained streaming mode up to 245 MB/s

- 2,5 GBit x1 PCIe Interface
- Works with x1/x4/x8/x16* PCIe slots
- Software compatible to PCI
- Sustained streaming mode up to 160 MB/s

Operating Systems

- Windows 2k, XP, Vista, 7
- Linux Kernel 2.4 + 2.6
- Windows/Linux 32 and 64 bit

Recommended Software

- Visual Basic, Visual C++, Borland C++ Builder, GNU C++, Borland Delphi, .VB.NET, C#, J#, Python
- SBench 6

Drivers

- MATLAB
- LabVIEW, LabWindows
- DASYLab
- Agilent VEE

Model	1 channel	2 channels	4 channels
M2i.3010	80 MS/s		
M2i.3011	40 MS/s	40 MS/s	
M2i.3012	80 MS/s	40 MS/s	
M2i.3013	40 MS/s	40 MS/s	40 MS/s
M2i.3014	80 MS/s	80 MS/s	40 MS/s
M2i.3015	160 MS/s	80 MS/s	
M2i.3016	160 MS/s	80 MS/s	40 MS/s
M2i.3020	100 MS/s		
M2i.3021	50 MS/s	50 MS/s	
M2i.3022	100 MS/s	50 MS/s	
M2i.3023	50 MS/s	50 MS/s	50 MS/s
M2i.3024	100 MS/s	100 MS/s	50 MS/s
M2i.3025	200 MS/s	100 MS/s	
M2i.3026	200 MS/s	100 MS/s	50 MS/s
M2i.3027	100 MS/s	100 MS/s	
M2i.3031	60 MS/s	60 MS/s	
M2i.3033	60 MS/s	60 MS/s	60 MS/s

General Information

The 17 models of the M2i.30xx series are designed for the fast and high quality data acquisition. Each of the up to four input channels has its own A/D converter and its own programmable input amplifier. This allows to record signals simultaneously on all channels with 12 bit resolution without any phase delay between them. The extremely large on-board memory allows long time recording even with the highest sampling rates. All boards of the M2i.30xx series may use the whole installed on-board memory for the currently activated number of channels. A FIFO mode is also integrated on the board. This allows the acquisition of data continuously for online processing or for data storage to hard disk.

*Some x16 PCIe slots are for the use of graphic cards only and can not be used for other cards.

Software Support

Windows drivers

The cards are delivered with drivers for Windows 2000, XP, XP64, Vista and Vista64 as well as Windows 7. Programming examples for Visual C++, Borland C++ Builder, LabWindows/CVI, Borland Delphi, Visual Basic, VB.NET, C# and J# are included.

Linux Drivers



All cards are delivered with full Linux support. Pre compiled kernel modules are included for the most common distributions like RedHat, Fedora, Suse or Debian. The Linux support includes SMP systems, 32 bit and 64 bit systems, versatile programming examples for Gnu C++ as well as the possibility to get the driver sources for own compilation.

SBench 6

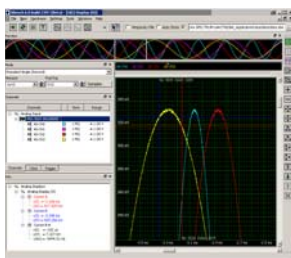

A base licence of SBench 6 the easy-to-use graphical operating software for the Spectrum cards is included in the delivery. Using the base licence it is possible to test the card and to show acquired data. There are also some basic measurement functions included in the base licence. The card comes with a demo license for the professional

version giving the user the opportunity to test the features of the professional version with the new hardware. Existing customers have the opportunity to request a demo license for the professional version at Spectrum. The professional version contains several new measurement functions, FFT, import and export (including MATLAB and ASCII) as well as the streaming modes. The data streaming modes allow to continuously acquire data to hard disk. SBench 6 has been optimized to handle data files of several GByte. More details on SBench 6 are found in the dedicated SBench 6 data sheet. The version 6 is running under Windows as well as under Linux (KDE and GNOME). A test version of SBench 6 is freely available in the internet. This test version will also operate with demo cards and can be tested as Professional version without any hardware installed.

Third-party products

A lot of third-party products are supported as an option. Choose between LabVIEW, MATLAB, DASYLab and Agilent VEE. All drivers come with examples and detailed documentation.

Hardware features and options

PCI/PCI-X



The cards with PCI/PCI-X bus connector use 32 Bit and up to 66 MHz clock rate for data transfer. They are 100% compatible to Conventional PCI > V2.1. The universal interface allows the use in PCI slots with 5 V I/O and 3.3 V I/O voltages as well as in PCI-

X or PCI 64 slots. The maximum sustained data transfer rate is 245 MByte/s per bus segment.

PCI Express



The cards with PCI Express use a x1 PCIe connector. They can be used in PCI Express x1/x4/x8/x16 slots, except special graphic card slots, and are 100% software compatible to

Conventional PCI > V2.1. The maximum sustained data transfer rate is 160 MByte/s per slot.

Input Amplifier

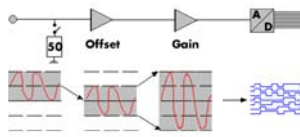

The analog inputs can be adapted to real world signals using a wide variety of settings that are individual for each channel. By using software commands the input termination can be changed

between 50 Ohm and 1 MOhm, one can select a matching input range and the signal offset can be compensated for.

Digital inputs

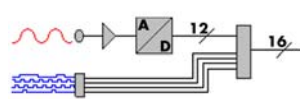

This option acquires additional synchronous digital channels phase-stable with the analog data. When the option is installed there are 4 additional digital inputs for every analog A/D channel.

Ring buffer mode

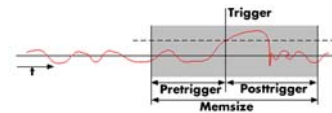

The ring buffer mode is the standard mode of all oscilloscope boards. Data is written in a ring memory of the board until a trigger event is

detected. After the event the posttrigger values are recorded. Because of this continuously recording into a ring buffer there are also samples prior to the trigger event visible: Pretrigger = Memsize - Posttrigger.

FIFO mode

The FIFO mode is designed for continuous data transfer between measurement board and PC memory (up to 245 MB/s on a PCI-X slot, up to 125 MB/s on a PCI slot and up to 160 MB/s on a PCIe slot) or hard disk. The control of the data stream is done automatically by the driver on interrupt request. The complete installed on-board memory is used for buffer data, making the continuous streaming extremely reliable.

Channel trigger

The data acquisition boards offer a wide variety of trigger modes. Besides the standard signal checking for level and edge as known from oscilloscopes it's also possible to define a window trigger. All trigger modes can be combined with the pulsewidth trigger. This makes it possible to trigger on signal errors like too long or too short pulses. In addition to this a re-arming mode (for accurate trigger recognition on noisy signals) the AND/OR conjunction of different trigger events is possible. As a unique feature it is possible to use deactivated channels as trigger sources.

External trigger I/O

All boards can be triggered using an external TTL signal. It's possible to use positive or negative edge also in combination with a programmable pulse width. An internally recognised trigger event can - when activated by software - be routed to the trigger connector to start external instruments.

Pulse width

Defines the minimum or maximum width that a trigger pulse must have to generate a trigger event. Pulse width can be combined with channel trigger, pattern trigger and external trigger.

Multiple Recording

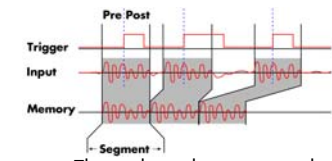

The Multiple Recording option allows the recording of several trigger events with an extremely short re-arming time. The hardware doesn't need to be restarted in between. The on-board memory is divided in several segments of the same size. Each of them is filled with data if a trigger event occurs. Pre- and posttrigger of the segments can be programmed. The number of acquired segments is only limited by the used memory and is unlimited when using FIFO mode.

Gated Sampling

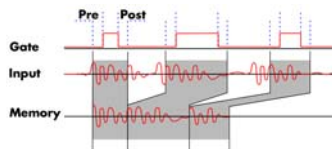

The Gated Sampling option allows data recording controlled by an external gate signal. Data is only recorded if the gate signal has a programmed level. In addition a pre-area before start of the gate signal as well as a post area after end of the gate signal can be acquired. The number of gate segments is only limited by the used memory and is unlimited when using FIFO mode.

Timestamp

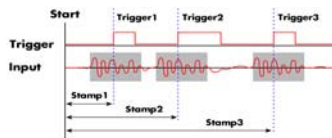

The timestamp option writes the time positions of the trigger events in an extra memory. The timestamps are relative to the start of recording, a defined zero time, externally synchronised to a radio clock, or a GPS receiver. With this option acquisitions of systems on different locations can be set in a precise time relation.

ABA mode

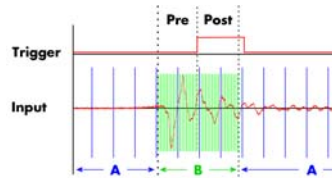

The optional ABA mode combines slow continuous data recording with fast acquisition on trigger events. The ABA mode works like a slow data logger combined with a fast digitizer. The exact position of the trigger events is stored as timestamps in an extra memory.

External clock I/O

Using a dedicated connector a sampling clock can be fed in from an external system. It's also possible to output the internally used sampling clock to synchronise external equipment to this clock.

Option differential inputs

With a simple software command two single-ended inputs can be combined to one differential channel. The difference is calculated in hardware on the digital side. The difference calculation is done in real-time using the current sampling rate of the card. Both inputs of the difference signal are still related to GND.

Reference clock

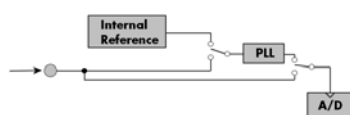

The option to use a precise external reference clock (normally 10 MHz) is necessary to synchronize the board for high-quality measurements with external equipment (like a signal source). It's also possible to enhance the quality of the sampling clock in this way.

The driver automatically generates the requested sampling clock from the fed in reference clock.

Star-Hub



The star-hub is an additional module allowing the phase stable synchronisation of up to 16 boards in one system. Independent of the number of boards there is no phase delay between all channels. The star-hub distributes trigger and clock information between all boards. As a result all connected boards are running with the same clock and the same trigger. All trigger sources can be combined with OR/AND allowing all channels of all cards to be trigger source at the same time. The star-hub is available as 5 card and 16 card version. The 5 card version doesn't need an extra slot.

271 synchronous cards with theSystem Star-Hub

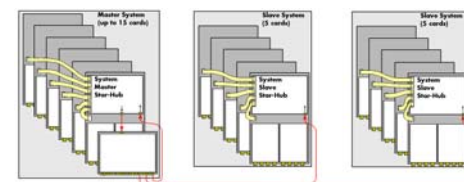

With the help of multiple system star-hubs it is possible to link up to 17 system phase synchronous with each other. Each system can then contain up to 16 cards (master only 15). In total 271 cards can be used fully synchronously in a bunch of systems. One master system distributes clock and trigger signal to all connected slave systems.

BaseXIO (enhanced trigger)



The BaseXIO option offers 8 asynchronous digital I/O lines on the base card. The direction can be selected by software in groups of four. Two of these lines can also be used as additional external trigger sources. This allows the building of complex trigger conjunctions with external gated triggers as well as AND/OR conjunction of multiple external trigger sources like, for example, the picture and row synchronisation of video signals. In addition one of the I/O lines can be used as reference clock for the Timestamp counter.

External Amplifiers



For the acquisition of extremely small voltage levels with a high bandwidth a series of external amplifiers is available. Each of the one channel amplifiers is working with a fixed input impedance and allows - depending on the bandwidth - to select different amplification levels between $\times 10$ (20 dB) up to $\times 1000$ (60 dB). Using the external amplifiers of the SPA series voltage levels in the μV and mV area can be acquired.

Technical Data

Analog Inputs

Resolution	12 bit
Differential non linearity (DNL)	≤ 1 LSB (ADC)
Integral non linearity (INL)	≤ 1 LSB (ADC)
Offset error	can be calibrated by user
Gain error	< 1% of current value
Programmable input offset	±100% of current input range
Crosstalk 1 MHz signal, 50 Ohm term	< -70 dB between any adjacent channels
Input signal with 50 Ohm termination	max 5 V rms
Analog Input impedance	50 Ohm / 1 MOhm 25 pF
Over voltage protection (range ≤ ±1 V)	±5 V
Over voltage protection (range > ±1 V)	±50 V
Connector (analog and trigger/clock)	3 mm SMB male

Trigger

Multi, Gate: re-arming time	<4 Samples
Max Pretrigger at Multi, Gate, FIFO	8176 Samples as sum of all active channels
Internal trigger accuracy	1 Sample
Channel trigger resolution	10 bits
Trigger output delay	One positive edge after internal trigger event
External trigger type	3.3V LVTTTL compatible (5V tolerant)
External trigger input	Low ≤ 0.8 V, High ≥ 2.0 V, ≥ 8 ns in pulse stretch mode, ≥ 2 clock periods all other modes
External trigger maximum voltage	-0.5 V up to +5.7 V (internally clamped to 5.0V, 100 mA max. clamping current)
External trigger accuracy (≤100 MS/s)	1 Sample
External trigger accuracy (>100 MS/s)	2 Samples
External trigger output levels	Low ≤ 0.4 V, High ≥ 2.4 V, TTL compatible
External trigger output drive strength	Capable of driving 50 ohm load

Power consumption (max speed)

	PCI / PCI-X		PCI EXPRESS	
	3,3 V	5 V	3,3 V	12 V
M2i.30x0 (128 MS memory)	2.2 A	0.8 A	0,4 A	1,0 A
M2i.30x1, x2 (128 MS memory)	2.3 A	0.9 A	0,4 A	1,1 A
M2i.30x5, x7 (128 MS memory)	2.5 A	1.1 A	0,4 A	1,2 A
M2i.30x3, x4, x6 (128 MS memory)	2.6 A	1.4 A	0,4 A	1,4 A
M2i.3026 (2 GS memory), max. power	3.7 A	1.4 A	0,4 A	2,0 A

Max channels with Star-Hub

	SH5	SH16	SSH55	SSHS16
M2i.30x0	5	16	85	271
M2i.30x1, 30x2, 30x5, 30x7	10	32	170	542
M2i.30x3, 30x4, 30x6	20	64	340	1084

BaseXIO (Option)

BaseXIO Connector (extra bracket)	8 x SMB (8 x MMCMX internal)
BaseXIO input	TTL compatible: Low ≤ 0.8 V, High ≥ 2.0 V
BaseXIO input impedance	4.7 kOhm towards 3.3 V
BaseXIO input maximum voltage	-0.5 V up to +5.5 V
BaseXIO output levels	TTL compatible: Low ≤ 0.4 V, High ≥ 2.4 V
BaseXIO output drive strength	32 mA maximum current

Digital Inputs (Option)

Digital inputs: input impedance	110 Ohm @ 2.5V
Digital inputs delay to analog sample	-11 Samples
Maximum voltage	-0.3 V up to +5.5 V
Input voltage	Low ≤ 0.8 V, High ≥ 2.0 V
Connector (digital inputs)	40 pole half pitch (Hirose FX2 series)

Differential Inputs (Option)

Available for card types	30x1, 30x2, 30x3, 30x4, 30x6
Differential Resolution	13 bit
Trigger mode restrictions	No channel trigger on ch1 (and ch3)

Certifications and Compliances

EMC Immunity	Compliant with CE Mark
EMC Emission	Compliant with CE Mark
Product warranty	2 years starting with the day of delivery
Software and firmware updates	Life-time, free of charge
MTBF	100000 hours

Clock

Internal clock range (PLL mode)	1 kS/s to max (see table below)
Internal clock accuracy	20 ppm
Internal clock: max. jitter in PLL mode	TBD
Internal clock: max. jitter in quartz mode	TBD
Internal clock setup granularity (≤ 100 M)	≤1% of range (100M, 10M, 1M, 100k,...)
Internal clock setup granularity example	range 1M to 10M: stepsize ≤ 100k
Internal clock setup granularity (> 100 M)	one fixed value (160 MS/s or 200 MS/s)
Reference clock: external clock range	≥ 1.0 MHz and ≤ 125.0 MHz
External clock range	1 MS/s to max (see table below)
External clock delay to internal clock	5.4 ns
External clock type	3.3V LVTTTL compatible
External clock input	Low ≤ 0.8 V, High ≥ 2.0 V, duty 45% - 55%
External clock maximum voltage	-0.5 V up to +3.8 V (internally clamped to 3.3V, 100 mA max. clamping current)
External clock output levels	Low ≤ 0.4 V, High ≥ 2.4 V, TTL compatible
External clock output drive strength	Capable of driving 50 ohm load

Environmental and Physical details

Dimension (PCB only)	312 mm x 107 mm (full PCI length)
Width (Standard or star-hub 5)	1 full size slot
Width (star-hub 16)	2 full size slots
Width (with digital inputs)	1 full size slots + 1 half size slot
Weight (depending on options/channels)	290g (2 ch) up to 460g (4 ch + dig + sh)
Warm up time	10 minutes
Operating temperature	0°C - 50°C
Storage temperature	-10°C - 70°C
Humidity	10% to 90%

PCI / PCI-X specific details

PCI / PCI-X bus slot type	32 bit 33/66 MHz
PCI / PCI-X bus slot compatibility	32/64 bit, 33-133 MHz, 3,3 and 5 V I/O

PCI EXPRESS specific details

PCIe slot type	x1
PCIe slot compatibility	x1/x4/x8/x16*

*Some x16 PCIe slots are for graphic cards only and can not be used for other cards.

Software programmable parameters

Input Ranges	±200 mV, ±500 mV, ±1 V, ±2 V, ±5 V, ±10 V
Input impedance	50 Ohm / 1 MOhm
Input Offset	±100% of input range in steps of 1%
Clock mode	Int. PLL, int. quartz, ext. clock, ext. divided, ext. reference clock, sync
Clock impedance	50 Ohm / high impedance (> 4kOhm)
Trigger impedance	50 Ohm / high impedance (> 4kOhm)
Trigger mode	Channel, Extern, SW, Auto, Window, Pulse, Re-Arm, Or/And, Delay
Trigger level	10 bit resolution: 1/1024 to 1023/1024 of input range
Trigger edge	Rising edge, falling edge or both edges
Trigger pulse width	0 to [64k - 1] samples in steps of 1 sample
Trigger delay	0 to [64k - 1] samples in steps of 1 sample
Memory depth	8 up to [installed memory / number of active channels] in steps of 4
Posttrigger	4 up to [8G - 4] samples in steps of 4
Multiple Recording segment size	8 up to [installed memory / 2 / active channels] in steps of 4
Multi / Gated pretrigger	0 up to [8k samples / number of active channels - 16]
ABA clock divider	1 up to [64k - 1] in steps of 1
Synchronization clock divider	2 up to [8k - 2] in steps of 2
Channel selection	Any 1, 2 or 4 channels (see manual for clock limits on the selections)

Dynamic Parameters

	M2i.3011 M2i.3013	M2i.3021 M2i.3023	M2i.3031 M2i.3033	M2i.3010 M2i.3012 M2i.3014	M2i.3020 M2i.3022 M2i.3024 M2i.3027	M2i.3015 M2i.3016	M2i.3025 M2i.3026
max internal clock	40 MS/s	50 MS/s	62.5 MS/s	80 MS/s	105 MS/s	160 MS/s	200 MS/s
max external clock	40 MS/s	50 MS/s	62.5 MS/s	80 MS/s	105 MS/s	80 MS/s	105 MS/s
-3 dB bandwidth	DC to 20 MHz	DC to 20 MHz	DC to 30 MHz	DC to 40 MHz	DC to 40 MHz	DC to 40 MHz	DC to 40 MHz
Zero noise level (< 125 MS/s)	< 1.1 LSB rms	< 1.1 LSB rms	< 1.4 LSB rms	< 1.5 LSB rms	< 1.5 LSB rms	< 2.0 LSB rms	< 2.0 LSB rms
Zero noise level (> 125 MS/s)	n.a.	n.a.	n.a.	n.a.	n.a.	< 3.0 LSB rms	< 3.0 LSB rms
Test - sampling rate	40 MS/s	50 MS/s	60 MS/s	80 MS/s	100 MS/s	80 MS/s	100 MS/s
Test signal frequency	1 MHz 4 MHz	1 MHz 4 MHz	1 MHz 4 MHz	1 MHz 9 MHz	1 MHz 9 MHz	1 MHz 9 MHz	1 MHz 9 MHz
SNR (typ) (dB)	66.2 64.8	65.2 64.5	64.5 63.5	65.2 63.3	65.1 63.0	65.0 62.8	65.0 62.5
THD (typ) (dB)	-74.0 -71.0	-72.3 -71.0	-70.5 -68.9	-72.2 -66.5	-72.0 -66.1	-69.8 -65.9	-69.5 -65.8
SFDR (typ), excl. harm. (dB)	80.4 77.9	80.2 77.8	80.0 78.0	79.0 77.9	78.0 77.5	78.2 77.0	77.8 76.9
ENOB based on SNR (bit)	10.7 10.5	10.6 10.4	10.5 10.3	10.6 10.2	10.6 10.2	10.5 10.1	10.4 10.1
ENOB based on SINAD (bit)	10.6 10.3	10.5 10.2	10.3 10.1	10.4 10.1	10.4 10.1	10.4 10.0	10.3 9.9

Dynamic parameters are measured at ± 1 V input range (if no other range is stated) and 50 Ohm termination with the samplerate specified in the table. Measured parameters are averaged 20 times to get typical values. Test signal is a pure sine wave of the specified frequency with > 99% amplitude. SNR and RMS noise parameters may differ depending on the quality of the used PC. SNR = Signal to Noise Ratio, THD = Total Harmonic Distortion, SFDR = Spurious Free Dynamic Range, SINAD = Signal Noise and Distortion, ENOB = Effective Number of Bits. For a detailed description please see application note 002.

Hardware block diagram

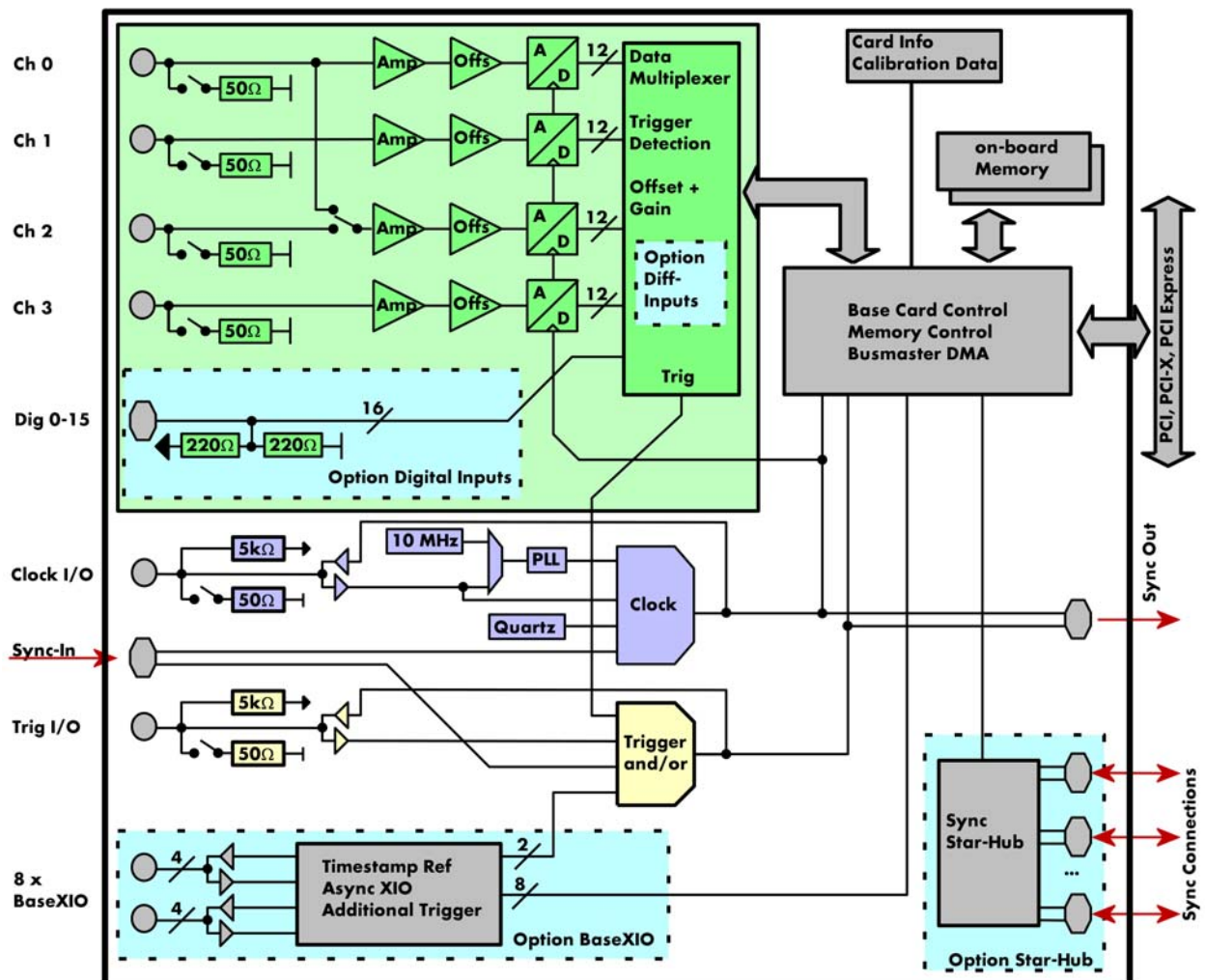

Order Information

PCI/PCI-X PCI Express	PCI/PCI-X	PCI Express	Standard mem	1 channel	2 channels	4 channels
	M2i.3010	M2i.3010-exp	128 MSample	80 MS/s		
	M2i.3011	M2i.3011-exp	128 MSample	40 MS/s	40 MS/s	
	M2i.3012	M2i.3012-exp	128 MSample	80 MS/s	40 MS/s	
	M2i.3013	M2i.3013-exp	128 MSample	40 MS/s	40 MS/s	40 MS/s
	M2i.3014	M2i.3014-exp	128 MSample	80 MS/s	80 MS/s	40 MS/s
	M2i.3015	M2i.3015-exp	128 MSample	160 MS/s	80 MS/s	
	M2i.3016	M2i.3016-exp	128 MSample	160 MS/s	80 MS/s	40 MS/s
	M2i.3020	M2i.3020-exp	128 MSample	100 MS/s		
	M2i.3021	M2i.3021-exp	128 MSample	50 MS/s	50 MS/s	
	M2i.3022	M2i.3022-exp	128 MSample	100 MS/s	50 MS/s	
	M2i.3023	M2i.3023-exp	128 MSample	50 MS/s	50 MS/s	50 MS/s
	M2i.3024	M2i.3024-exp	128 MSample	100 MS/s	100 MS/s	50 MS/s
	M2i.3025	M2i.3025-exp	128 MSample	200 MS/s	100 MS/s	
	M2i.3026	M2i.3026-exp	128 MSample	200 MS/s	100 MS/s	50 MS/s
	M2i.3027	M2i.3027-exp	128 MSample	100 MS/s	100 MS/s	
	M2i.3031	M2i.3031-exp	128 MSample	60 MS/s	60 MS/s	
	M2i.3033	M2i.3033-exp	128 MSample	60 MS/s	60 MS/s	60 MS/s

Memory

Order no.	Option
M2i.xxxx-256MS	Memory upgrade to 256 MSample (512 MB) total memory
M2i.xxxx-512MS	Memory upgrade to 512 MSample (1 GB) total memory
M2i.xxxx-1GS	Memory upgrade to 1 GSample (2 GB) total memory
M2i.xxxx-2GS	Memory upgrade to 2 GSample (4 GB) total memory

Options

Order no.	Option
M2i.xxxx-mr	Option Multiple Recording
M2i.xxxx-mgt	Option pack including Multiple Recording, Gated Sampling, Timestamp
M2i.xxxx-mgtab	Option pack including Multiple Recording, Gated Sampling, Timestamp, ABA mode
M2i.xxxx-diff	Digital differential mode for combining two single-ended channels to one differential channel.
M2i.xxxx-SH5 (1)	Synchronization Star-Hub for up to 5 cards, only 1 slot width
M2i.xxxx-SH16 (1)	Synchronization Star-Hub for up to 16 cards
M2i.xxxx-SSHM (1)	System-Star-Hub Master for up to 15 cards in the system and up to 17 systems, sync cables included
M2i.xxxx-SSHS5 (1)	System-Star-Hub Slave for up to 5 cards in one system, all sync cables included
M2i.xxxx-SSHS16 (1)	System-Star-Hub Slave for up to 16 cards in one system, all sync cables included
M2i.3xxx-dig	Additional synchronous digital inputs (4 per analog channel) including Cab-d40-idx-100
M2i.xxxx-bxio	Option BaseXIO: 8 digital I/O lines usable as asynchronous I/O, timestamp ref-clock and additional external trigger lines, additional bracket with 8 SMB connectors
M2i-upgrade	Upgrade for M2i.xxxx: later installation of option -dig or -bxio

Cables

Order no.	Option
Cab-3f-9m-80	Adapter cable SMB female to BNC male, 80 cm
Cab-3f-9f-80	Adapter cable SMB female to BNC female, 80 cm
Cab-3f-3f-80	Adapter cable SMB female to SMB female, 80 cm
Cab-3f-9m-200	Adapter cable SMB female to BNC male, 200 cm
Cab-3f-9f-200	Adapter cable SMB female to BNC female, 200 cm
Cab-3f-3f-200	Adapter cable SMB female to SMB female, 200 cm
Cab-3f-9f-5	Adapter cable SMB female to BNC female, 5 cm (short cable especially for oscilloscopes probes)
Cab-d40-idx-100	Flat ribbon cable 40 pole FX2 for digital connector to 2x20 pole IDC connector, 100 cm
Cab-d40-d40-100	Flat ribbon cable 40 pole FX2 for digital connector to 40 pole digital FX2 connector, 100 cm

Amplifiers

Order no.	Bandwidth	Input Impedance	Coupling	Amplification
SPA.1601 (2)	500 MHz	50 Ohm	DC	x10 (20 dB)
SPA.1412 (2)	200 MHz	1 MOhm	AC/DC	x10/x100 (20/40 dB)
SPA.1411 (2)	200 MHz	50 Ohm	AC/DC	x10/x100 (20/40 dB)
SPA.1232 (2)	10 MHz	1 MOhm	AC/DC	x100/x1000 (40/60 dB)
SPA.1231 (2)	10 MHz	50 Ohm	AC/DC	x100/x1000 (40/60 dB)
SPA.PW1-120 (2)	External power supply for all SPA amplifiers with 120 VAC, type A (US, Japan) connector			
SPA.PW1-230 (2)	External power supply for all SPA amplifiers with 230 VAC, type C (European) connector			
Information	External Amplifiers with one channel, BNC connections, manually adjustable offset, manually switch between settings. A power supply need to be ordered for each amplifier!			

Drivers

Order no.	Option
M2i.xxxx-ml	MATLAB driver for all M2i and M2i Express cards
M2i.xxxx-lv	LabVIEW driver for all M2i and M2i Express cards
M2i.30xx-dl	DASYLab driver for all M2i.30xx cards
M2i.30xx-vee	Agilent VEE driver for all M2i.30xx cards

SBench6

Order no.	Option
SBench6	Base version which support standard mode for one card
SBench6-Pro	Professional version for one card: FIFO mode, export/import, calculation functions
SBench6-Multi	Option multiple cards: needs Professional version. Handles multiple synchronized cards in one system.
Volume Licenses	Please ask Spectrum for details.

(1) : Just one of the options can be installed on a card at a time.

(2) : Third party product with warranty differing from our export conditions. No volume rebate possible.

Technical changes and printing errors possible